

SPECIFICATION

PHOTO:



PRODUCT DESCRIPTIONS

1. Adopt high brightness LEDs as light source with low light decay.
2. High density and flexibility with good heat dissipation.
3. 2 OZ FPC, with good quality PVC cover.
4. Easy to install and preserve, can be bent freely
5. High color efficiency, uniform illumination with wide view beam angle
6. Low voltage (DC12V or DC24V) for human safety, various colors available.

DETAILS:

MODEL : 12V-NEON-816

SIZE: 8X16MM

POWER: 9W/M

INPUT VOLTAGE : DC12V

CCT: 3000K / 4000K / 6500K / BLUE / RED/ GREEN/ PINK/ AMBER/ ICE BLUE

LUMINOUS FLUX: 800lm/M

POWER FACTOR: >0.5

IP RATING : IP65

CRI: Ra>80

LIFESPAN: 15000hrs

LIGHT SOURCE : LED 2835 SMD - 120 LEDs

MATERIAL : COPPER PCB + LEDs

PACKAGE: 50M/ROLL/COLOR BOX ,CUTTABLE .

WARRANTY : 1 YEAR WARRANTY

CONNECT METHOD :

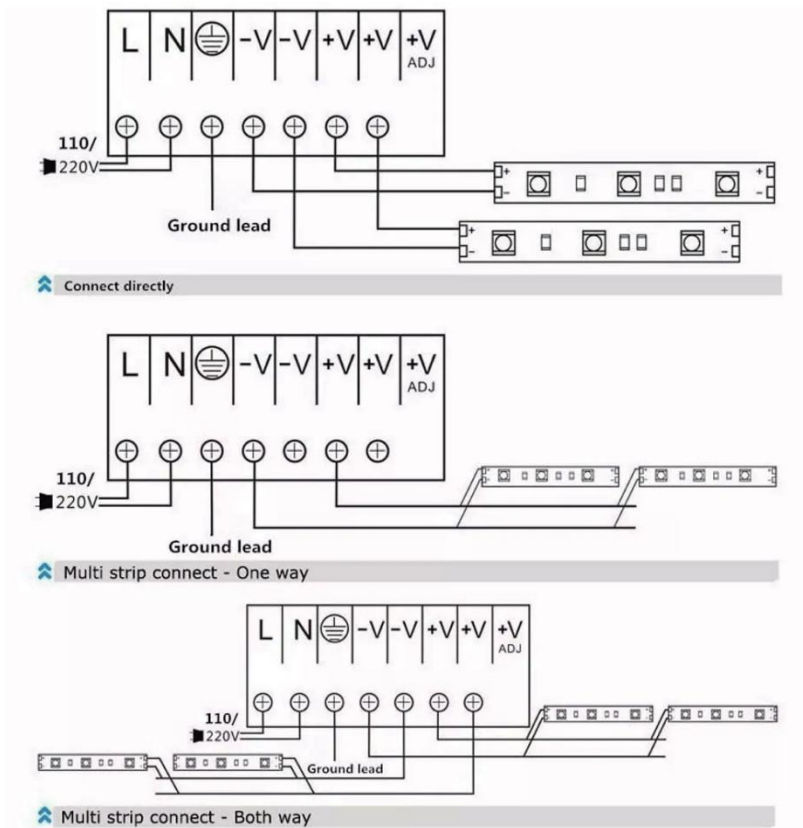

APPLICATION:

IN DOOR LIGHTING ONLY , HOME DECARATION , BEDROOM, ETC.

